



Krystal Klear

18 O'shea Dr, Nerang QLD 4211, Australia | 043 318 0892 | info@companydomain.com



Krystal Klear

CONTENTS

Window Series

Door Series

Curtain walls

Balustrades

Certification

Product Processes

Exhibitions

Contacts

WINDOW SERIES — SLIDING WINDOWS

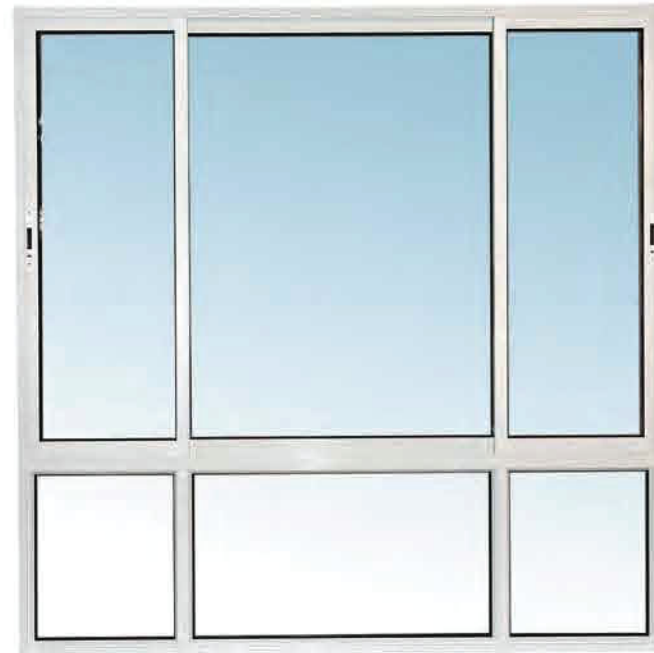

Aluminum sliding window design is a perfect solution to save the outdoor and indoor space. This is patent product and has been tested under Sai Global's labs. Sliding windows have energy rating accredited by Wers, AWA.

FEATURES

- * Characteristics of compact structure
- * Good performance in water resistance, heat & sound insulation
- * Flyscreen slide way is designed inside and outside to fit window frame
- * Design with fin or without fin for different construction structures

DESCRIPTION

- * Profile: Aluminium, thermal break aluminium, PVC, aluminum-wood composite
- * Safety Glass: Double glazed 5-6(or 9)-5mm, 4-9(or12)-4mm
 - Single glazed 4/5/6mm
 - Laminated: 6.38mm, 8.76mm, 10.38mm, 10.76mm, 12.38mm, 12.76mm etc
 - Low-E, tinted/coated/obscure
- * Glass seal: Rubber, silicone, weather proof sealant
- * Flyscreen: Fiber glass, crimesafe, aluminum grill with fiber glass
- * Hardware: China Brand, Doric, Lockwood, German brand

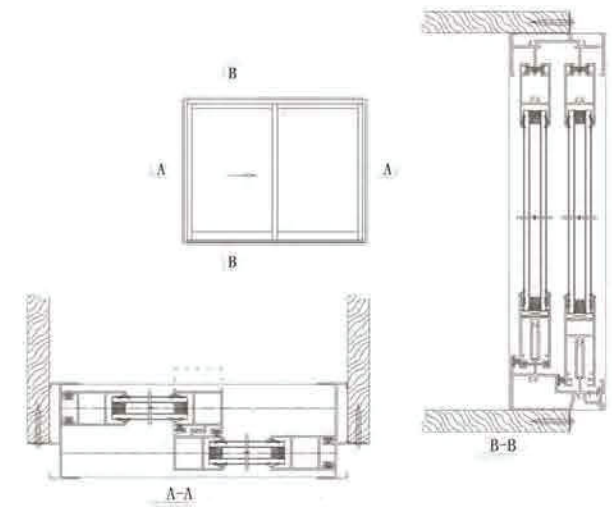
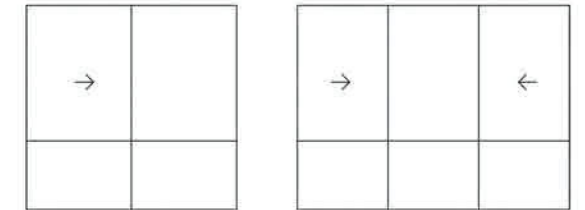
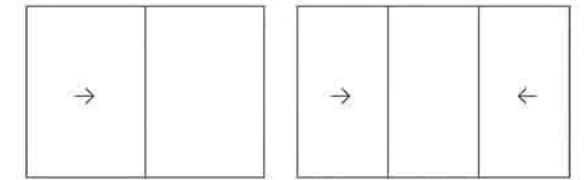

WINDOW SERIES — AWNING WINDOWS



Awning window is a type of window design that allows the window sash to swing outward rather than inward or up and down. This is self-developed and has been tested under Sai Global's labs. Awning windows have perfect energy rating accredited by Wers AWA.

FEATURES

- * Excellent performance in water resistance, heat & sound insulation, energy efficient
- * Characteristics of compact structure, strong structure with angle connector
- * Match with winder or handle
- * Easy-to-clean fixed flyscreens
Design with fin or without fin for different construction structures

DESCRIPTION

- Profile: Aluminum, PVC, aluminum-wood composite
- * Safety Glass: Double glazed 5-6(or 9)-5mm, 4-9(or12)-4mm
- * Single glazed 4/5/6mm
- Laminated: 6.38mm, 8.76mm, 10.38mm, 10.76mm, 12.38mm, 12.76mm etc
- Low-E, tinted/frosted/obscure
- Glass seal: Rubber, silicone, weather proof sealant
- * Flyscreen: Fiber glass, soft and thin steel mesh.
- Hardware: China Brand, Doric, Lockwood,
- * German brand

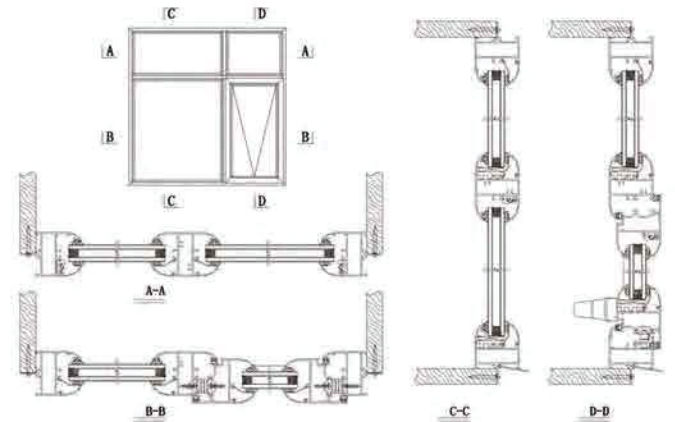
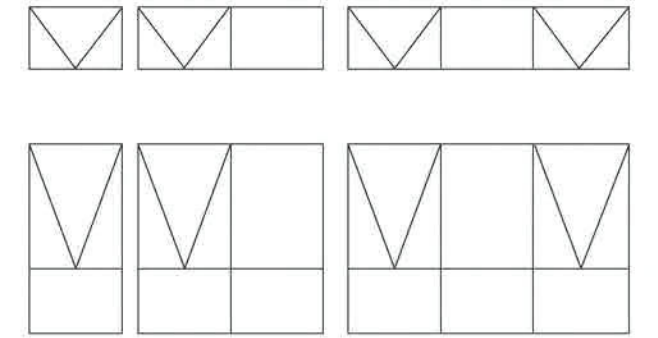
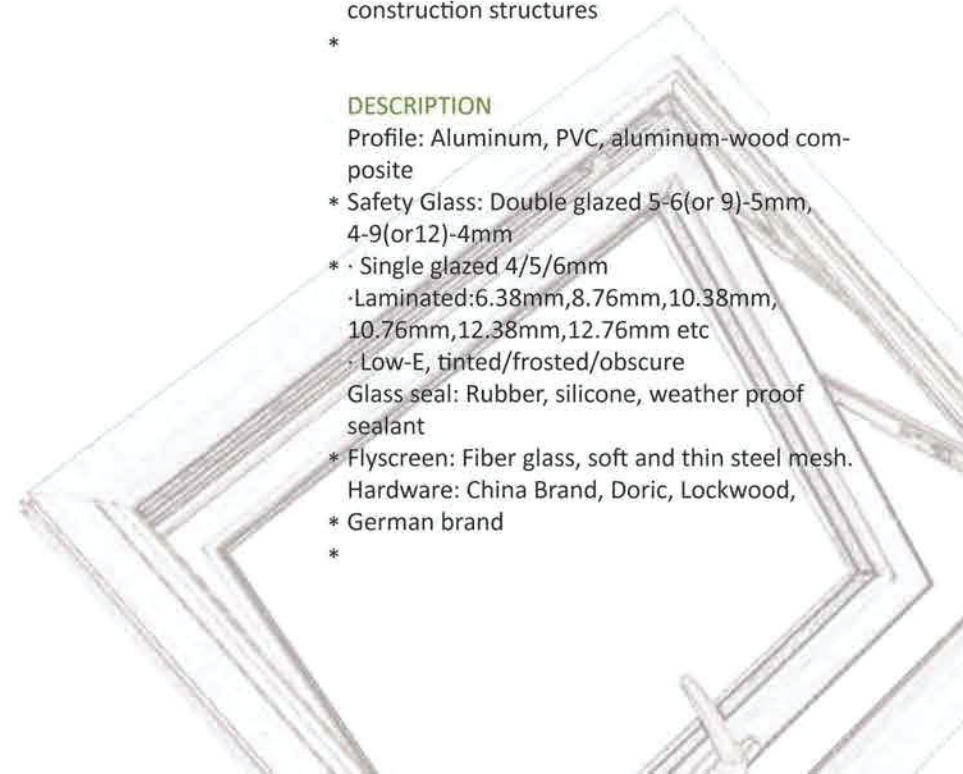

WINDOW SERIES — CASEMENT AND TILT & TURN WINDOWS

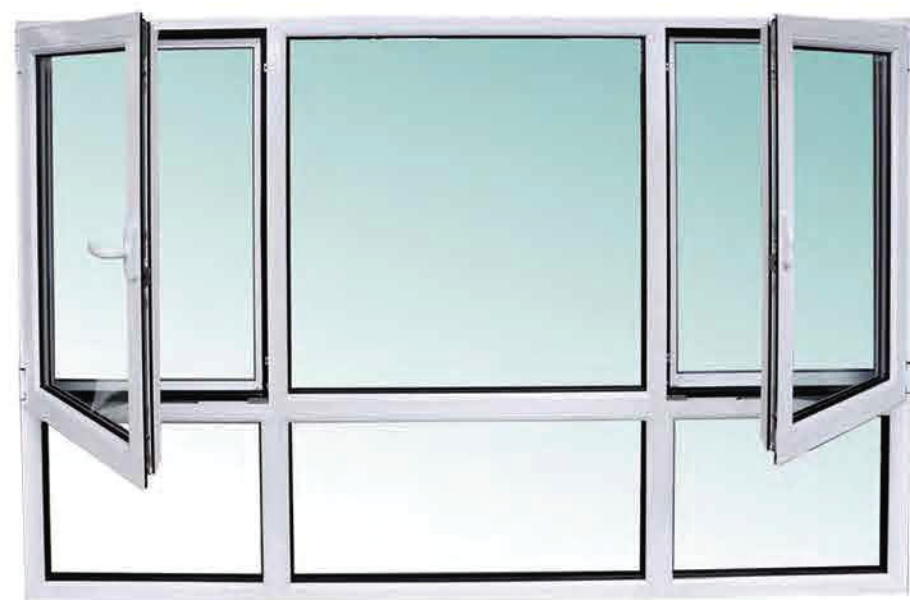

FEATURES

- * 45° assembly with designed aluminum angle connector inserted
- * Design with fin or without fin for different construction structure, more options of installation method
- * Custom size and configuration, smart blind is optional
- * 0 Air infiltration

DESCRIPTION

- * Profile: Aluminium, thermal break aluminium, PVC, aluminum-wood composite
- * Safety Glass: Double glazed 5-9(or 12)-5mm 6-12-6mm
 - Single glazed 4/5/6mm
 - Laminated: 6.38mm, 8.76mm, 10.38mm, 10.76mm, 12.38mm, 12.76mm etc
 - Low-E, tinted/frosted/obscure
- * Glass seal: Rubber, silicone, weather proof sealant
- * Flyscreen: Fiber glass retractable/Fix
- * Hardware: China Brand, Doric, Lockwood, German brand

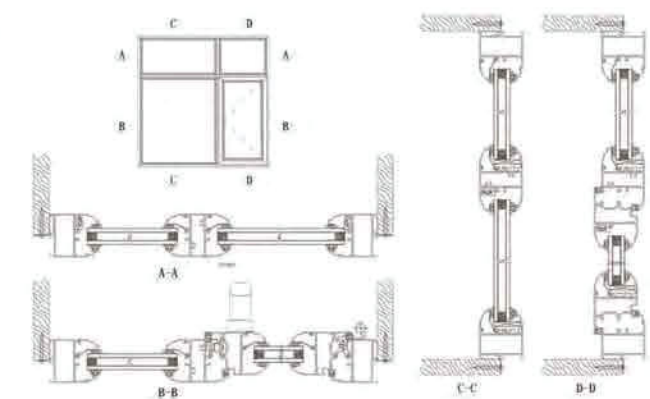
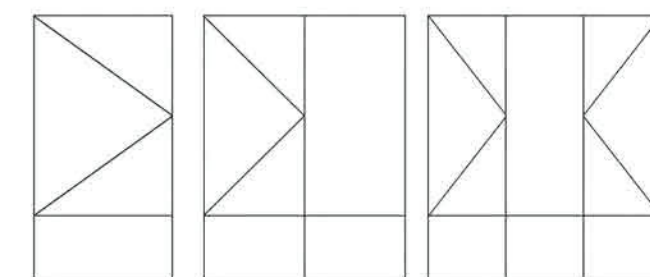
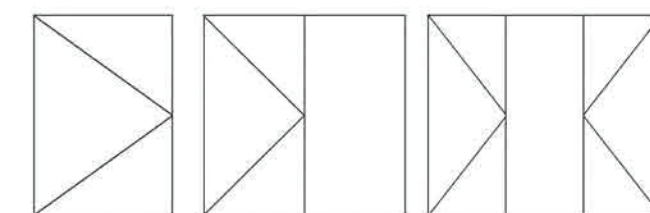

LOUVERS DOORS & WINDOWS



Offering the ultimate in vision and ventilation, AluVison louvers provide an attractive and practical window alternative. Louvre windows ensure your view is as uninterrupted as possible while the tilt-adjustable blades allow you to control the flow of air throughout the home.

FEATURES

- * Excellent vision and ventilation
- * Offer you the choice to install a wide range of glass or aluminum blades
- * Adjustable or Fix shutter blades

DESCRIPTION

- *Profile: Aluminum
- *Safety Glass: 6mm
- *Hardware: China Brand, Doric, Lockwood, German brand

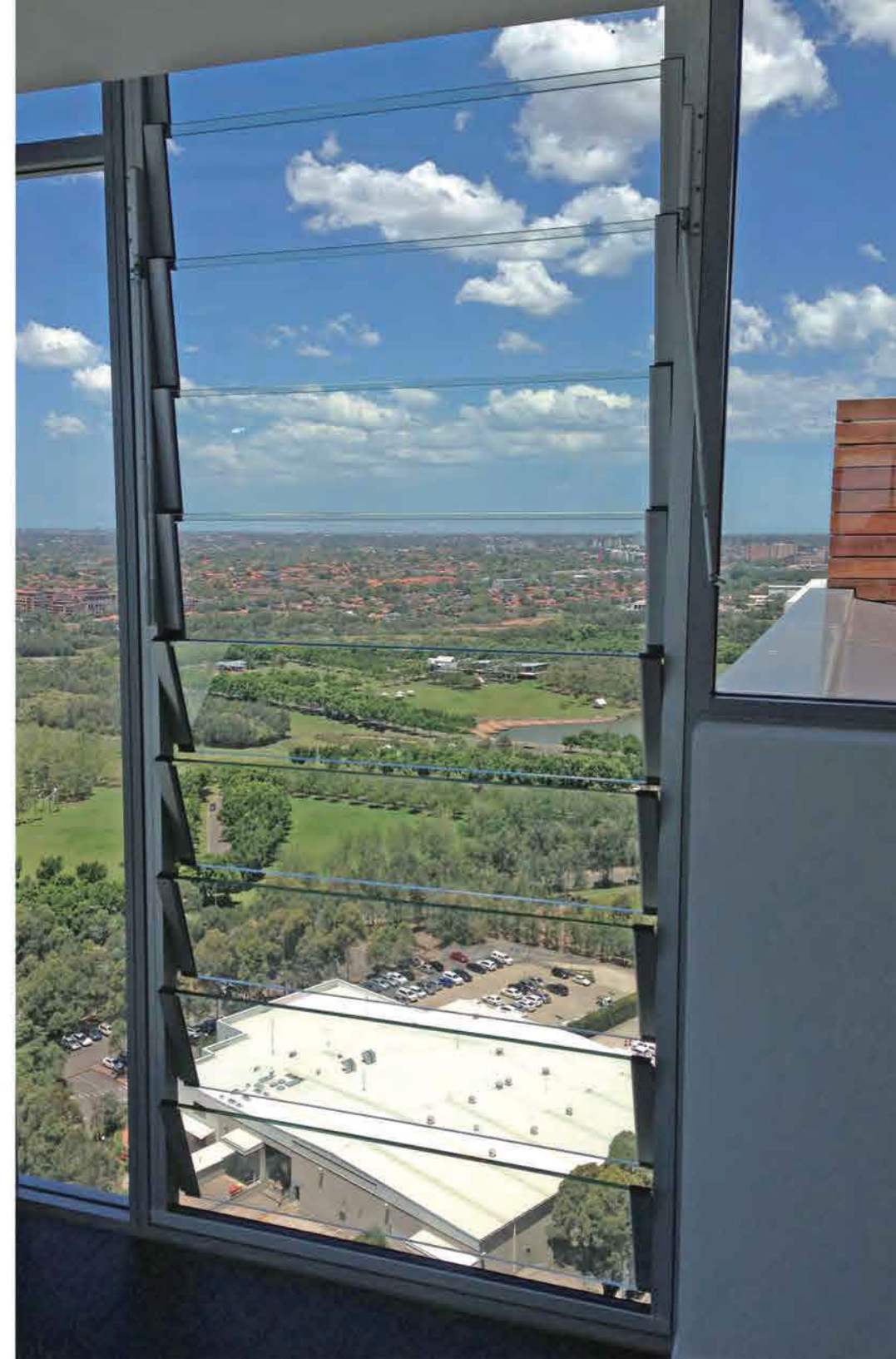

DOOR SERIES — BI-FOLD DOORS & WINDOWS



Aluminum bi-fold doors are an efficient way of dividing rooms and separating hallways without wasting space. This is self-developed door has been tested under Sai Global's labs. Bi-fold doors have energy rating accredited by Wers AWA.

FEATURES

- * Smart and delicate appearance
- * Low bottom frame: 20mm/38mm height
- * Various opening style
- * Flexible pushing and pulling
- * Characteristics of compact structure
- * Good performance in water resistance, heat & sound insulation

DESCRIPTION

- * Profile: Aluminium, thermal break aluminium, aluminum-wood composite
- * Safety Glass: Double glazed 5-9(or 12)-5mm, 4-12-4mm
 - Single glazed 4/5/6mm
 - Laminated: 6.38mm, 8.76mm, 10.38mm, 10.76mm, 12.38mm, 12.76mm etc
 - Low-E, tinted/frosted/obscure
- * Glass seal: Rubber, silicone, weather proof sealant
- * Hardware: China Brand, Doric, Lockwood, German brand

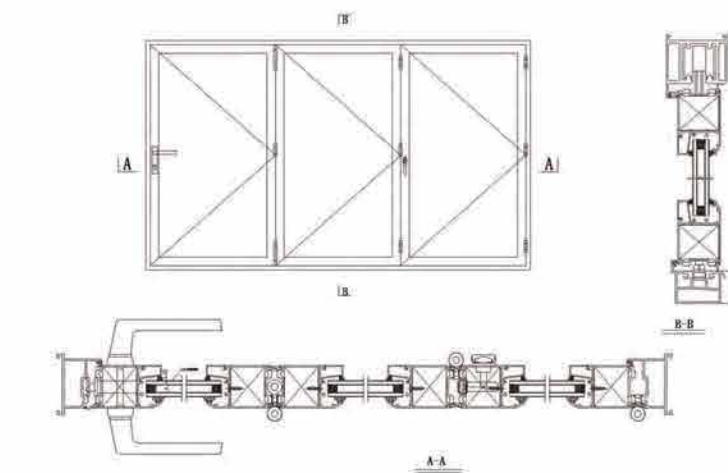
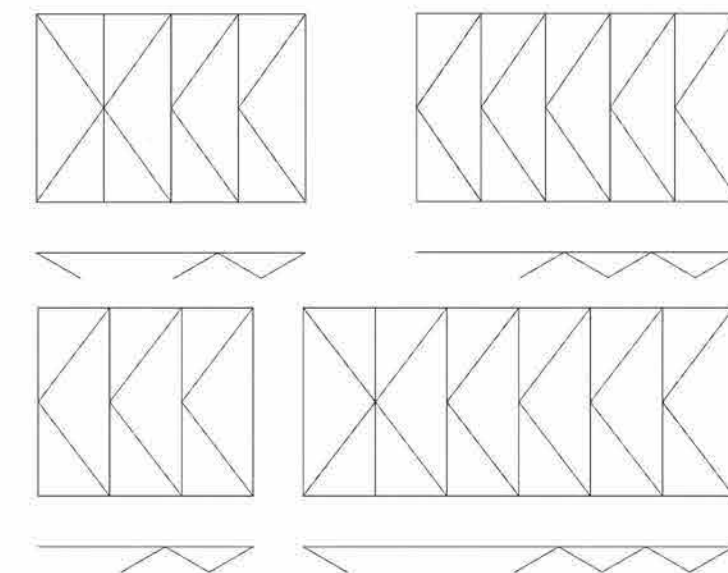

DOOR SERIES — SLIDING DOORS



Aluminum sliding door design is a perfect solution to save the outdoor and indoor space. This is a patent product developed by our team and has been tested under Sai Global's labs. Sliding doors have energy rating accredited by Wers AWA.

FEATURES

- * Characteristics of compact structure
- * Excellent performance in water resistance, heat & sound insulation
- * Flyscreen slide way is designed inside and outside of window frame
- * Design with fin or without fin for different construction structure
- * More options for installation like Face Fix
- * Custom size and configuration

DESCRIPTION

- * Profile: Aluminium, thermal break aluminium, PVC, aluminum-wood composit
- * Safety Glass: Double glazed 5-6(or 9)-5mm, 4-9(or 12)-4mm
 - Single glazed 4/5/6mm
 - Laminated:6.38mm,8.76mm,10.38mm, 10.76mm,12.38mm etc
 - Low-E, tinted/frosted/obscure
- *Glass seal: Rubber, silicone, weather proof sealant,
- *Flyscreen: Fiber glass , crimesafe, aluminum grill with fiber glass
- *Hardware: China Brand, Doric, Lockwood, German brand

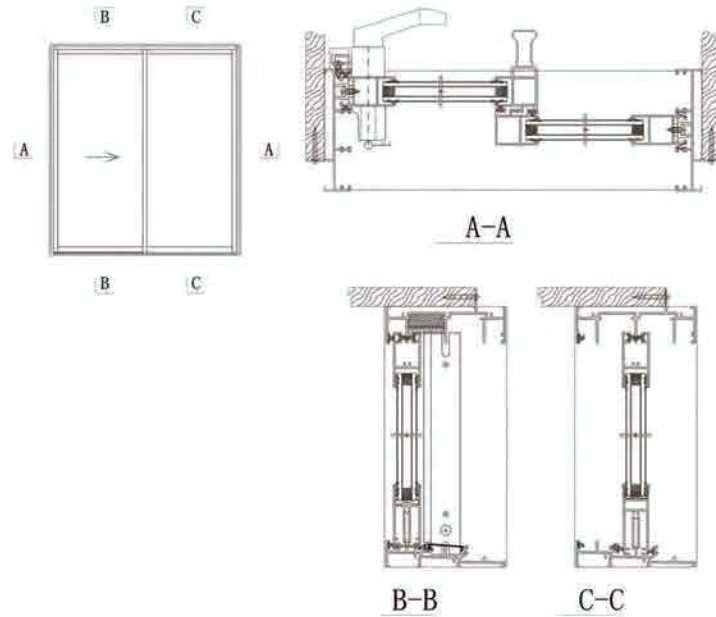
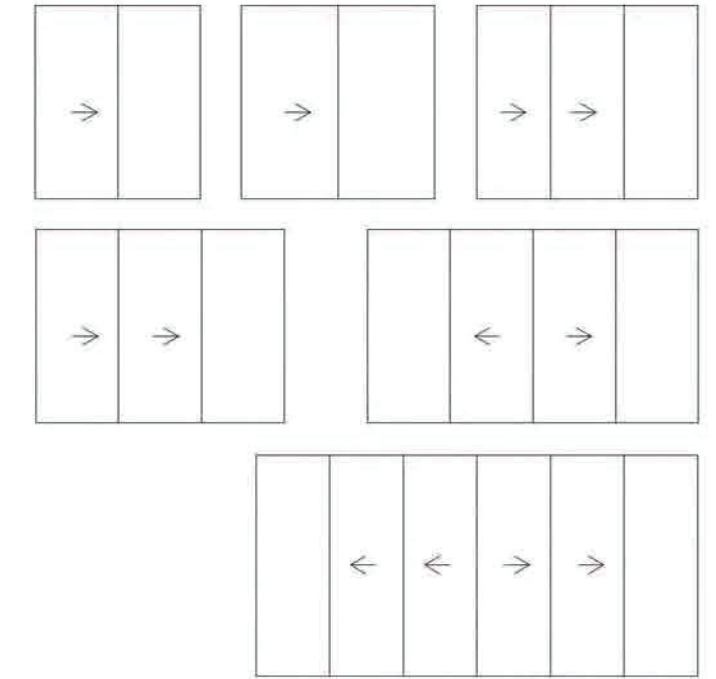

DOOR SERIES — CASEMENT DOORS



FEATURES

45° assembly with designed aluminum angle connector inserted
 Design with fin or without fin for different construction structure,
 more options of installation method.
 Custom size and configuration, smart blind is optional
 0 Air infiltration

DESCRIPTION

- *Profile: Aluminium, thermal break aluminium, PVC, aluminum-wood composite,
- *Safety Glass: Double glazed 5-9(or 12)-5mm
- Single glazed 4/5/6mm
- Laminated: 6.38mm,8.76mm,10.38mm,10.76mm,12.38mm etc
- Low-E, tinted/frosted/obscure
- *Glass seal: Rubber, silicone, weather proof sealant,
- *Flyscreen: Fiber glass retractable
- *Hardware: China Brand, German brand

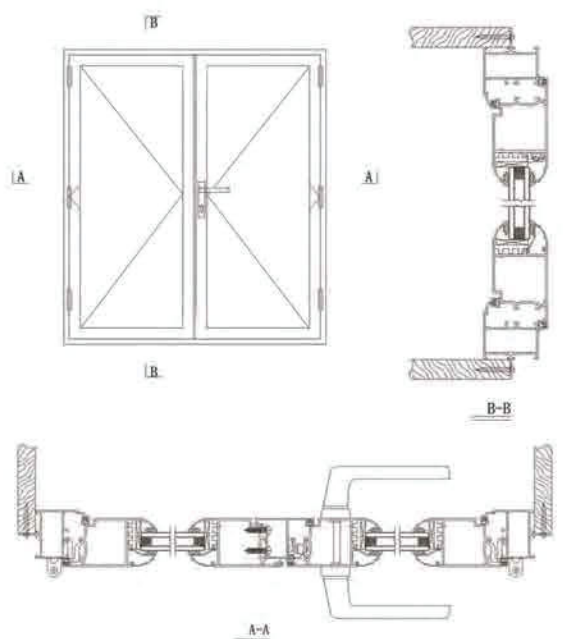
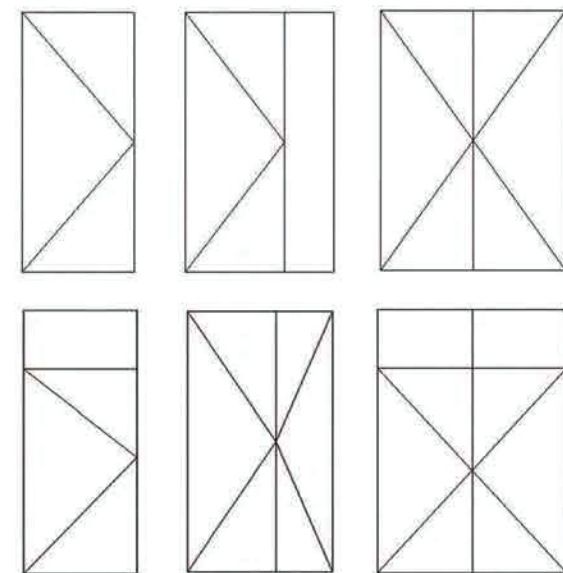

COMMERCIAL SERIES — FL100 SERIES



Commercial series is mainly used for commercial buildings and apartments. Feilong has updated the system offering a clean and modern external appearance with a range of frame depths 100mm.

FEATURES

Designed with subhead, subsill and subframe which make installation easy.
Characteristics of compact structure
Excellent performance in water resistance, heat & sound insulation
Feilong commercial system can incorporate structurally glazed mullion profiles and offers a number of operable door and window options

DESCRIPTION

- *Profile: Aluminum
- *Safety Glass: Double glazed 6-12-6mm, 6.38-12-6mm, 8.76-12-6mm, 10.76-9-6mm
- Single glazed 6/8/10mm
- Low-E, tinted/frosted/obscure
- *Glass seal: Rubber, silicone, weather proof sealant,
- *Flyscreen: Fiber glass
- *Hardware: China Brand, Doric, Lockwood, German brand

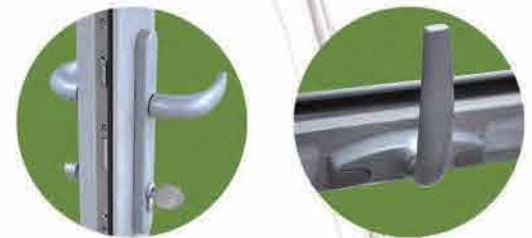
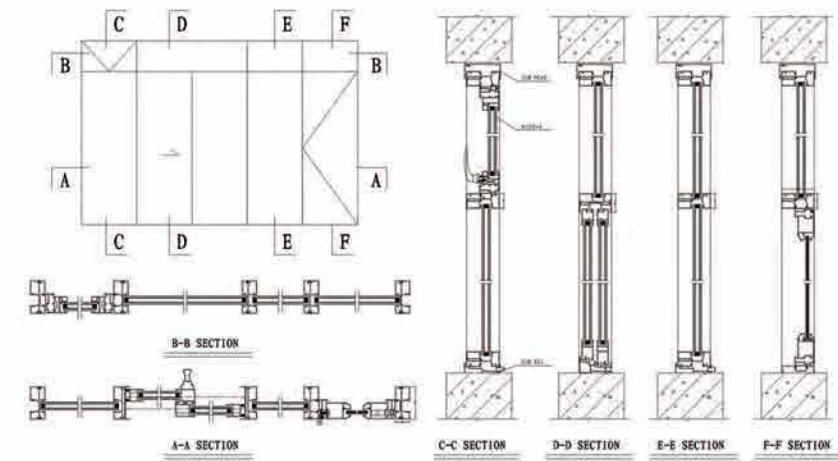
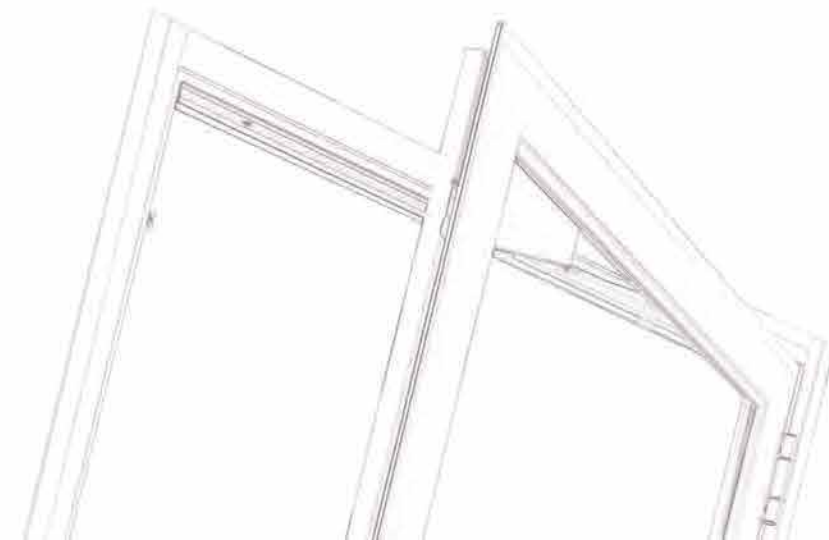

COMMERCIAL SERIES — FL150 & FL200 SLIDING DOORS

FL150 & FL200 series sliding door of four tracks is perfect product for commercial projects. It is a new patent door developed by Feilong, stronger than residential series, structure includes subsill and subhead. Can be 2, 3, 4, 6 & 8 panels, etc, with flexible opening methods.

FEATURES

- *Characteristics of compact structure
- *Excellent performance in water resistance, heat & sound insulation
- *Large panel to provide better view
- *Flat bottom frame design, can be flush with the floor
- *Allow flyscreens and security screens
- *Allow acoustic seal for better performance

DESCRIPTION

- *Profile: Powder coating aluminium, Colors are optional
- *Safety Glass: Double glazed 6-12-6mm, 8.76-12-6mm, 10.38-12-6mm
 - Single glazed: 5mm/6mm/8mm/10mm
 - Laminated: 6.38mm, 8.76mm, 10.38mm, 10.76mm, 12.38mm, 12.78mm etc
 - Low-E, tinted/frosted/obscure
- *Glass seal: Rubber, silicone, weather proof sealant
- *Flyscreen: Fiber glass, crimsafe like, aluminum grill with fiber glass
- *Hardware: China Brand, Doric, Lockwood

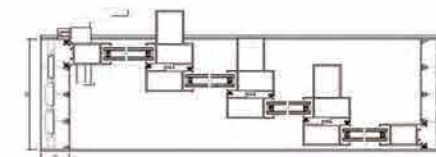
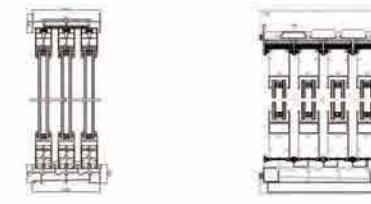
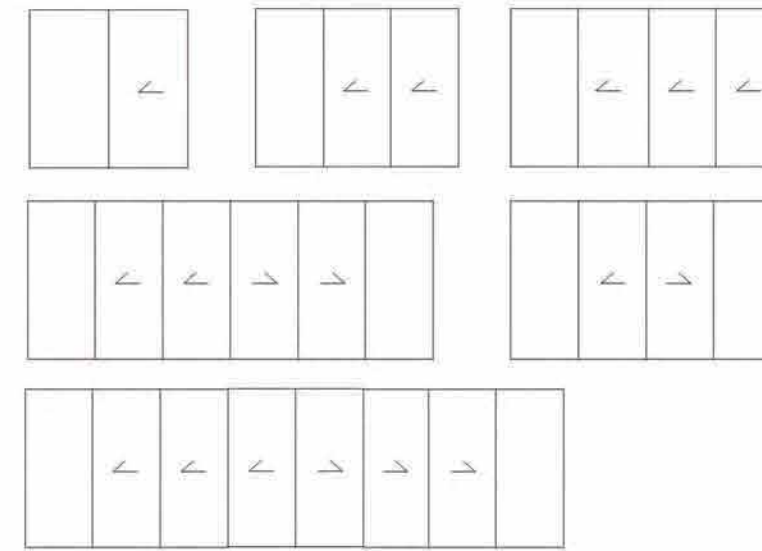

CURTAIN WALLS

Features & Benefits
 60X80mm, 60X100mm, 60X120mm, 60X140mm,
 60X180mm, 70X140mm, 70X180mm frame

Visible & Invisible options
 Double glazed as standard with single glazed and
 spandrel options
 Low-E, Coated, tinted glass options
 Proprietary mullion and building brackets provide a fully
 system
 Maturely advanced design and simple structure make
 installation easier
 The professional technology and service team provides
 flexible design of connection and precise accessories to
 ensure safe and reliable.
 Especially hollow structure has excellent insulation of
 heat and sound.

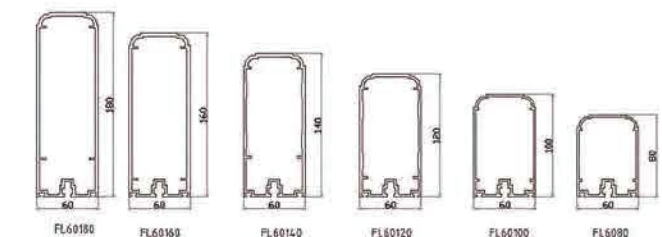
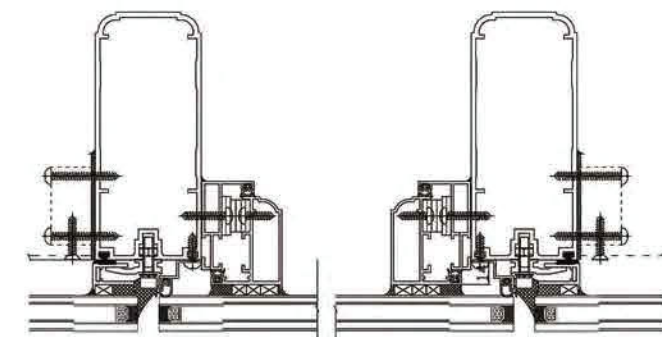
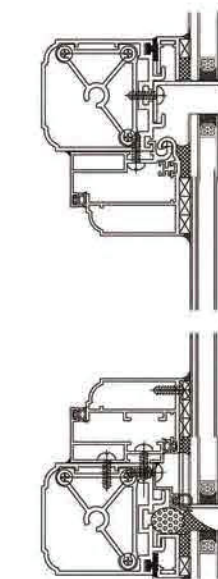
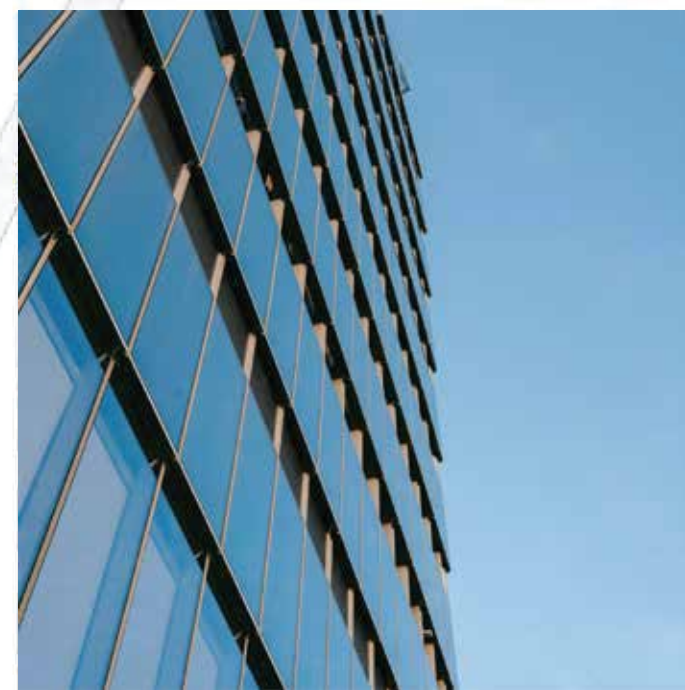

BALUSTRADES



Balustrade can be used as pool fencing, balcony fencing, also stair railing and handrail, to make a safe and artistic living environment.

FEATURES

Safe structure to safeguard your safety.
Different artistic style, to decorate your property.
Simple structure for easy fit and installation.

DESCRIPTION

- *Profile: Stainless steel or powder coated aluminum profile, solid wood
- *Safety Glass:
 - Glass thickness: 10/12 mm or other at client request
 - Clear, tinted/frosted/obscure
- *Hardware: stainless steel

